

# THE PICK & SHOVEL

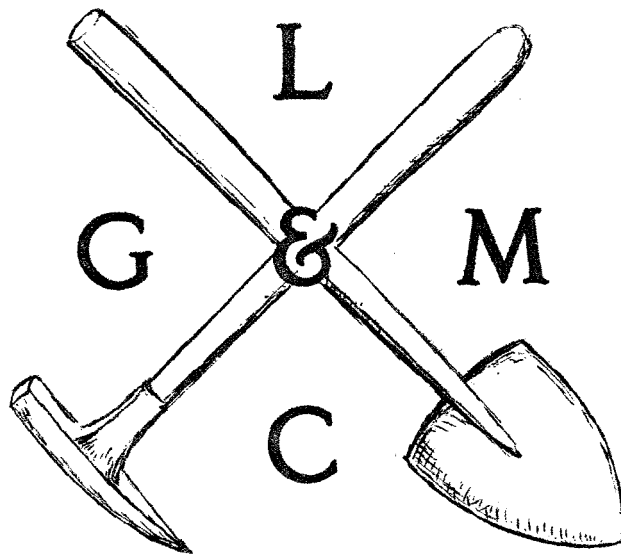

NOV 72

OFFICIAL PUBLICATION OF  
LINCOLN GEM & MINERAL CLUB

HOST OF COMBINED

MWF-AFMS NATIONAL SHOW AND CONVENTION  
AND NEBRASKA STATE SHOW

JUNE 13-16, 1974  
LINCOLN, NEBRASKA

## CALENDAR

REGULAR MEETING...7:30 PM, Sat. Nov. 18th, 1972  
Auditorium room of Morrill Hall  
14th & U Sts. Use east entrance.  
Parking should be available right close.



BUSINESS...Vote on proposed By-Law change.  
LGMC Board of Directors have approved the following proposed By-Laws change:  
ARTICLE IV Section 5(change '2' to '2 or more' tellers) to read  
The President shall appoint two or more tellers to conduct the election. The tellers shall report the results of the election before adjournment of the meeting.

ALSO...Election of Officers

PROGRAM..."Spectrum - The Science Fiction Universe" by Jack Dunn, in the Planetarium at Morrill Hall. This should be an interesting program as man's trips to the moon and his great technological advances have brought truth to many predictions first made in Science Fiction literature. In this program the Planetarium looks at some great stories and how they describe the Universe. (A rule of the Planetarium states 'no children under 5 will be permitted' so think accordingly.)

ROCK FEATURE of the month...TOPAZ, birthstone for November. Anything in topaz - jewelry, mineral specimens, etc.

FOSSIL FEATURE of the month...artifacts. Any shape or form...bring yours and compare.

REFRESHMENTS...will be provided by Vi & Larry Van-Cleave, Phyllis Parks, Marjorie Hedick, and the hospitality committee.

LGMC BOARD MEETING...Dec. 7, 1972, 7:30 PM at the home of Treasurer, Tam Dutcher, 5343 Cooper

LGMC STEERING COMMITTEE MEETING... Tuesday, Dec. 5, 1972-Rm.122, Nebr. Hall

" " " Special meeting with outstate clubs-Nov. 26, 1972

NEW MEMBERS...Don H. & Edna Carter, 1101 Driftwood Dr. 68510 ph 489-3443  
Maudie Gless (Mrs. Don), Rt. 2 Fremont, NE 68025 ph (412) 721-7054

NAME TAGS...available if you want one...order @ \$1.04 ea. through Pat Lawson

LGMC 1973 Annual Show, May 12-13, State Fairgrounds, Lincoln, Nebraska

AFMS and Eastern Federation Show and Convention, June 28 through July 1, Charlotte, NC

MWF Show, July 26-29, Cincinnati Convention Center, Cincinnati, Ohio

DEADLINE FOR DECEMBER BULLETIN...Nov. 27th, due to advancing the date of our Christmas meeting and party. Kathy Grabher has again been most helpful in preparing this issue. Thanks, Kathy.

GIVE A HOOT --- DON'T POLLUTE H.E.L.P. --- HELP ELIMINATE LITTER PLEASE

## Last Month

...our meeting started on time with 39 members present and before the meeting was over there were 60 members present plus guests. (It would be appropriate to point out here that promptness to our meetings is appreciated and we should all strive to acquire this habit...starting on time is important, especially if we have a guest speaker - it is a courtesy as well as a good habit...so get with it...be on time next time, OK?) Our guests were David Shaffer, Bob & Carol Anderson, Mr. & Mrs. Louis Stroud and family, and Mr. & Mrs. Don Carter. (We're always glad to see new faces in our midst...did you make them feel welcome? I hope so...). General business was covered; the nominating committee made their report (see listing elsewhere in this bulletin); request was made that reservations be made now with Norma Miller or Glenna McGinnis for the Christmas Party Dinner on Dec. 9 at our club room (\$1.75 each--menu was printed in last month's P & S); the field trip to Arkansas was discussed; the '74 Show committee heads were announced and comments made as to the function of each committee; request was made by the president for donations for a display for the blind to be placed at the Chet Ager Nature Center. The Program was most interesting and beautiful - slides of gems and minerals at the Smithsonian, narrated by Phyllis herself. (Well done, Phyllis). Our rock feature of the month was opal and that feature, along with Kay's Indian relics and Suiseki creations, Don Carter's case of minerals, and all the other goodies on display made one think we were having our annual show! It was great to see so many people sharing the hobby... thanks a lot. And keep up the good work - your involvement makes for a better meeting all the way around.

The request for original contributions to the P & S has begun to bring results, witness this issue. And several people have spoken to me of their good intentions...we do appreciate, and your material will be printed...just put 'er there!

GOOD NEWS...after all the lost time...the long, long wait..."Room 104" is no more...gone out of our infancy and toddler stage, keeping in step with the times.

A NEW NAME..."Museum Volunteers of Paleontology and Geology"  
 A NEW LOCATION...Nebraska Hall (Old Elgin Building). Use west door entrance on 16th St. and proceed to fourth floor.  
 TIME...7:30 PM prompt, Friday evenings.

What had so long been talked about is now a reality. A very new private room with all of the necessary equipment (still stored in our old cupboard which made the move ahead of us.)

A staff of three members, two old friends Charles & Karen Messenger, and a new friend, Bill Ravnak, whom some of you may have had the opportunity to meet at "Trail Side Museum" at Fort Robinson.

Those participating on the first night in our new location were Marg Heedick, Phyllis, Jim & Linda Parks (Linda working very hard on her needle point), Gene Eno, Vi and Larry VanCleave, and Norm & Dorothy Engelhart. We hope to see you-all next Friday.

-----the old bone-digger, Dottie Engelhart-----

FIELD TRIP INFO...at the October meeting only four people indicated they could go on the Arkansas field trip. In talking with field trip chairman, Tom Simmons, it was decided to cancel the trip for now. There is no reason why it could not be planned for next year...let the president know so future plans can be made.

Sincere sympathy to the Krejci's  
 in the loss of Ruth's father.

THE PRESIDENT'S MESSAGE

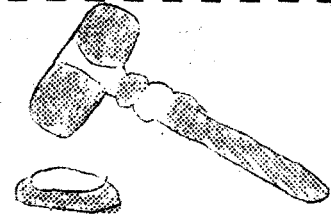

Election of officers and a fine program at the Planetarium, Morrill Hall, U.N. Campus should make the November 18th meeting a must for all members to attend. Parking is available in lots north of Morrill Hall.

Keep the Betty Crocker coupons coming in. Hopefully you will have the opportunity to meet the young lady Dr. Schultz chose to receive the scholarship award at our November meeting

Bring a suitable specimen that you feel the blind can enjoy for the Chet Agar Nature Center. Lynn Wells will accept your gift. Be sure your name and description accompanies your specimen.

Make your reservation for the Christmas Party with either Norma Miller or Glenna McGinnis. Let's make this a real happy occasion.

Welcome to these new members- Maud - wife of Don Gless and Mr. & Mrs. Carter. So glad to have you.

The State 4-H Extension office is in the process of making available a Geology project on a state wide bases. Roger Pabian is assisting them in preparing the manual for the project. This manual will also be available to other youth organizations. The club can be very proud to have one of their members assisting in this worth while project and that our club was instrumental in motivating this work.

I hope that every one will study carefully the picture our treasurer has drawn for us. This shows very clearly how our funds are spent in the operation of the club. If any one has any suggestions where we can cut expenses or raise money tell your board. The projected budget for 1972 was \$885 and our income for 1972 will be under \$800 for the year.

Dues for 1973 are now due and lets make this years goal 100% by January 1st. Either mail your dues to Tam Dutcher, 5343 Cooper, or pay them at the Noverber 18th meeting.

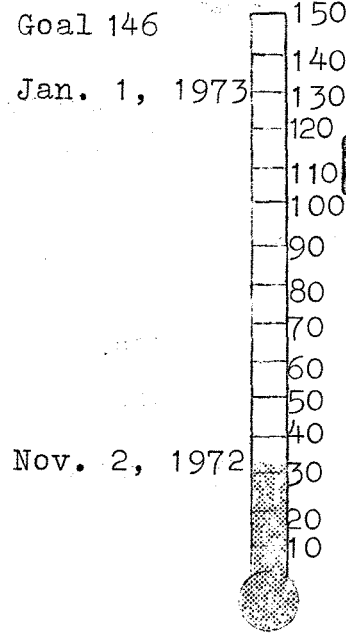

DUES ARE DUE

In closing let us be reminded and thankful for the many blessings we enjoy and not be so smug in our own contentment that we forget those less fortunate than us.

Have a happy Thanksgiving!

Marie Wells, President

MIDWEST FEDERATION CONVENTION OCTOBER 28, 1972

The meeting started with the State Directors assembly. More work is added to the State Directors this year. They will be responsible for clubs in their state to get material to the personnel in charge of Midwest Federation directories. This is to be accomplished by January 10, 1973.

The assembly of all delegates was called to order. A vote was called on for three new entries in competitive displays. All votes were cast in favor. A supplement will be added to rules competition books.

Mrs. Hersch gave a report on the Midwest Program Library. She remarked that the "Tri-State Area" program and the "Monster Dig" have been in great demand.

Mr. Paul Good, head of the bulletin editors committee, said the new manual on "Help to Bulletin Editors" would be in their hands by November 30.

Our Federation seems to be in fairly good shape financially. Assets of the beginning of the year (October 28, 1972) are nearly \$3,000.00.

Mr. Bernard F. Parr, the outgoing President, turned the jade gavel over to Mr. Lee M. Kirby, our new President.

Visitors from Canada were Mr. and Mrs. Brownlee of Windsor, Ontario. They were representatives of the Central Canadian Federation. They plan to attend our 1974 Show. A "hands across the border" policy between the two Federations is well under way.

The membership record as of October 25, 1972, gave the State of Nebraska six clubs with membership of 337. Total adult membership for the Federation is 15,817.

----- State Director, Howard Taylor

A Calendar is to be sent out by the Community Arts Council. Any publicity for the club should be sent in as soon as possible - i.e. - National meeting, or any special programs. Call 435-4126

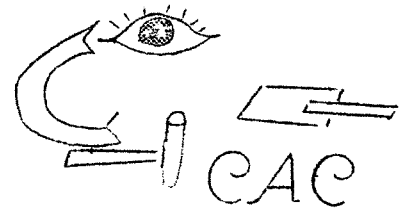

An Alternate from the club should be on the CAC mailing list. Let them know the name immediately. Call Norma Carpenter - 432-5037.

Dues of the organization - we are to let them know if the assessment they send is too high.

The Community Arts Council meetings are held on the 4th Monday of each month.

The Willa Cather Centennial on Dec. 7, 1973, is to be national in scope and plans are progressing now.

CAC Representative, Rev. Raymond Pfeiffer

-----  
THOUGHT FOR THE DAY...A little smile adds to your face value.

## BOARD MEETING MINUTES OF THE LINCOLN GEM &amp; MINERAL CLUB

Lincoln Gem & Mineral Club Board meeting was held Nov. 2, 1972 at 7:30 PM at the home of President, Marie Wells.

Board members present were Marie Wells, Tam Dutcher, Luella Paul, Jim Parks, Roger Pabian, Howard Taylor and Ralph Ulrich. Committee members present were Norma Miller, Pat Lawson, Kay Ulrich and Phyllis Parks.

The Secretary read the minutes of the October meeting and they were approved as read. The Treasurer gave the Treasurer's report and it was approved as read.

Outstanding bills were presented by the Treasurer and a motion was made by Ralph Ulrich for the outstanding bills to be allowed, seconded by Luella Paul. Motion carried. The Treasurer also reported that there were \$14.97 left in the Tod Ashmun Memorial for further disbursement on some other Memorial.

A motion was made by Ralph Ulrich and seconded by Tam Dutcher to accept the five new members for the Club and reading as follows: Don Carter, Edna Carter, Maude Gless, and Bob & Carol Anderson. Motion carried.

Ralph Ulrich, 1973 LGMC Show Chairman, reported some of his show chairmen in the various capacities that had been filled. He also stated that they were toying with maybe having a banquet again on Sat. evening instead of the Awards Breakfast on Sunday morning. Definite plans were not made as yet.

Ralph Ulrich, 1974 National Show Chairman gave a report as to its progress, also Marie Wells and Jim Parks reported on some of their work as committee members.

Ralph Ulrich made a motion that we reimburse Wilfrid Wittmann as a delegate to Ishpeming, Mich., in the amount of \$25.00, in July to the Midwest Federation Annual Convention. Seconded by Roger Pabian. Motion carried.

Following are "Proposed By-Law Changes" presented by Phyllis Parks in the absence of Frances Tracy, By-Laws Committee Chairman.

ARTICLE IV Section 5 (Change 2 tellers to 2 or more tellers')

To read The President shall appoint two or more tellers to conduct the election. The tellers shall report the results of the election before adjournment of the meeting.

ARTICLE V Section 4 - Quorum (change at least 3 of the Board of Directors to 5).

To Read Twenty percent (20%) of the adult membership including at least five (5) of the Board of Directors shall constitute a quorum for the transaction of business at any regular or special meeting of the organization. A majority of the Board of Directors shall constitute a quorum for the Board of Directors meetings.

ARTICLE VII (new) Parliamentary Authority

To Read All questions of parliamentary procedure not covered by these By-Laws shall be decided according to "Robert's Rules of Order."

ARTICLE VII Amendments (To change number of Article)

ARTICLE IX Enactment (To change number of Article) (continued next page)

Nov. 2, 1972 Board Meeting Minutes (cont'd.)

The proposed changes were discussed and then voted on by the Board as follows:

ARTICLE IV Section 5 was voted "YES"

ARTICLE V Section 4 was voted "NO"

ARTICLE VIII (New) was voted "NO"

Therefore ARTICLE VIII and ARTICLE IX (to change number of Article) was not necessary. The "Proposal Change" made will be presented at the next General Meeting (Nov. 18 at Morrill Hall).

The dues increase question was again brought up after making a motion in our September meeting "not to increase dues," (and the motion was carried.) It was brought up due to the fact that the reflection of the "Operating Cost of the Club exceeds the Income." Suggestion was therefore recommended by the President, Marie Wells, that all Board members should try and find a cheaper location for our Club's meetings to help alleviate some of this expenditure and if this deems possible an increase at this time would not be necessary.

The President appointed Roger Pabian as Chairman in preparing the Siouxland Traveling Trophy case for the year 1973.

Roger Pabian announced the progress made by the 4-H Geology Project, which is now presented throughout the State of Nebraska.

Next Board meeting will be at the home of Tam Dutcher on Dec. 7, 1972, at 7:30 PM.

Adjournment by Roger Pabian.

Luella S. Paul, Rec. Secy.

Dear Fellow Club Members:

Here is how we cut our expense "pie" for 1972. Total expense to November 1, 1972 is \$724.00

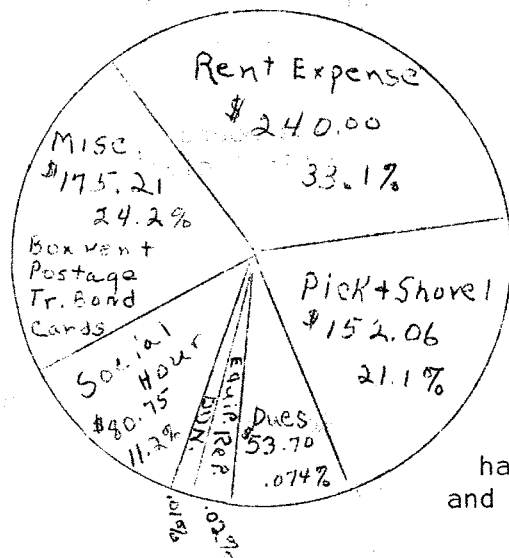

We have 146 paying adult members. We have 2 non-paying servicemen members. We have 4 charter non-paying members. We have a total of 20 junior members, making a total of all members 172.

The above total expense makes an average of \$4.20 per member, adult and junior, with November and December still ahead of us.

1972 dues paid totaled \$498.00 or an average of \$2.90 per member, adult and junior. We have had to draw from income from the 1972 show and the rock swap to help pay the expenses.

-Tam Dutcher, Treasurer

STEERING COMMITTEE-1974 SHOW COMMITTEE MEETING MINUTES-Oct.10,1972

Present: Steering Committee Members Ralph Ulrich, Irl Everett,  
Howard Taylor, (late arrival) Bruce Simon  
1974 Show Committee Members - Marie Wells, Roger Pabian,  
Kay Ulrich and Phyllis Parks

Opened with continuation of Policy File-

Re: Manufacturers and Distributors - Decision that they be considered just as retail dealers at the regular fee except that if they only wish to demonstrate a new or special product with no selling they are to be considered as a special feature under Division 9.

Policy File #9 - Special Features - needs more detail work before presenting for adoption.

Policy File #13 - Special Events - presented and accepted as amended, ready to print.

Ralph Ulrich was selected as Club's Liaison with the Administrative Assistant and Liaison with University of the University of Nebraska. He made the announcement that Mr. McMahan was not to be our contact, and that Mr. Virgil Miller would be our Administrative Assistant. Mr. Miller has started working on necessary reservations for scheduled meetings for the show.

Marie Wells reported on the committees visit with Economic Development Division of the State and their enthusiasm and information of materials which will be available for packets and publicity.

Decision that the secretary must keep a policy file register so that all copies of the file can be kept up to date on any necessary changes or additions made.

A review of the time schedule set by the Steering Committee at the preliminary meetings established that most items were very close to schedule.

Next meeting will be November 7, 1972 - Tuesday at 7:30 in the same room at Nebraska Hall. Discussion of outstate club participation will be held.

Respectfully submitted  
Phyllis Parks, Secy.

DATELINE NOV. 4...Lincoln Gem & Mineral Club members were shocked and saddened at the sudden death of member Jim Kratzer who was in attendance at our meeting last month yet and appeared to be in good health. Our sincere sympathy is extended to his family.

1973 NOMINATING COMMITTEE REPORT

The nominating committee, consisting of Norma Miller, John Lewis, Phyllis Parks, and Tom Simmons, have, according to the By-Laws and Constitution of the Lincoln Gem & Mineral Club, prepared the following slate of officer candidates for the year 1973:

- President - - - Roger Pabian
- 1st Vice-Pres. - Ralph Ulrich
- 2nd Vice-Pres. - George Balke (one to be elected)  
Frank Rule
- Secretary - - - Gladys Jeurink (one to be elected)  
Nelda Oliver
- Treasurer - - - Tam Dutcher

- Board Members:-
- Larry Bigley
  - Florence Boring
  - Don Eckel
  - John Harrison
  - Art Howlett (four to be elected)
  - Jim Parks
  - Raymond Pfeiffer
  - Tom Simmons
  - Howard Taylor
  - Don Lawson

(Additional nominations may be made from the floor with prior consent of the nominee)

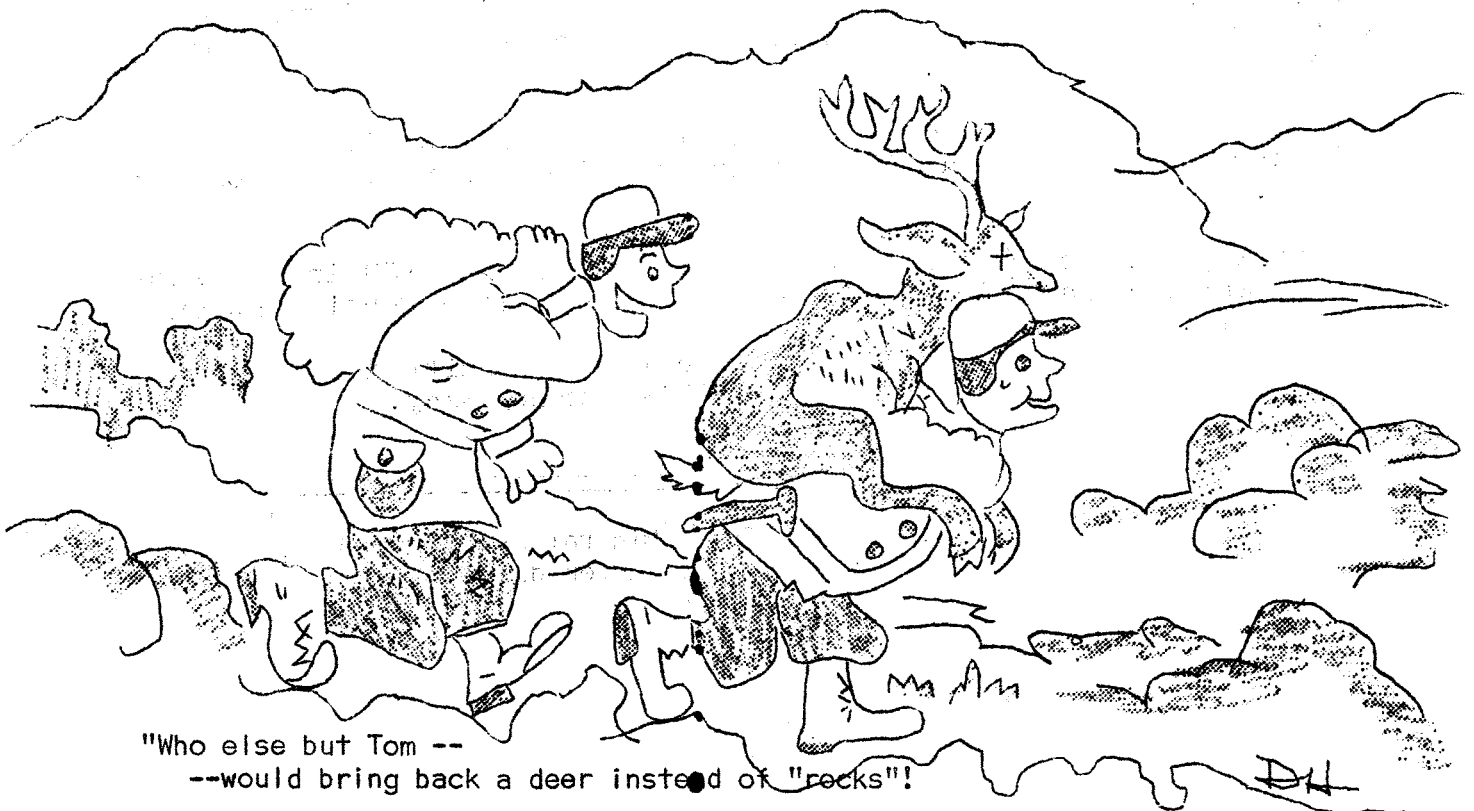

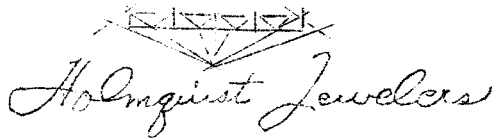

851 Stuart Building  
Lincoln, Nebraska  
Phone 435-7276

Hours: 10:00 AM-6:00 PM Monday thru Friday  
Evenings and weekends by appointment

We specialize in fine jewelry items, featuring designs and settings  
of international master craftsmen

Janet and Mike Holmquist

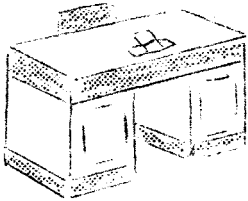

#### FROM THE DESK OF THE LIBRARIAN

New books given to the library and the donors are:

1. Lake Superior Agates - in memory of Tod Ashmun,  
given by George and Glenna McGinnis
2. Mineral Digest Volume II - given by Helena Baegl
3. Rockhound Primer of Arizona - given by Helena Baegl
4. Color Treasury of Crystals - given by Dot & George Balke
5. The Central Canadian Federation of Mineralogical Societies  
Directory - given by Howard Taylor

And many thanks for these fine donations.

Now for the nitty-gritty -- I am sorry to say that some disorder has occurred in the housekeeping of the library. We are taking inventory and in order to have a correct list of books for the 1973 Who's Who we must have all books turned in by the December meeting. Sadly, some books have been taken out without cards being made so we do not know who has them. Anyone having the following books please return them to the club librarian (either at her home or at the November or December meeting):

Geology by Field

Jewelry by Bovin

Minerals Yearbook 1947 by Pehrson

Minerals and Rocks by Pearl

Collecting Rocks and Minerals by Jensen

Fossils, An Introduction To by Mathews

Western Gem Hunters Atlas

Young Idea by Jay E. Farr (2 copies)

K. Ulrich, Librarian



VAJA CON DIOS - May God Be With You

Cards have been sent this month to:

Merle Geyer (get well)

Ruth Ternes (get well)

Jim Kratzer family (sympathy)

Ruth Kejci (sympathy)

## GLENNA'S GLEANINGS



The Lynn Wells were pleased to have their daughter, Nancy, home for the weekend from Sidney Nebr., where she is involved in a teaching program for trainable retarded individuals.

Marie Carveth was recently accorded the honor of "Homemaker of the Day" by station KFOR. The Rupert twins, Debra and David were responsible for her nomination. Congratulations, Marie!

Fred and Wanda Day were in Lincoln briefly from Flagstaff, Arizona, where they now reside, for the wedding of their daughter. Fred was kind enough to offer to arrange field trips in that area for club members who might be in the vicinity in the future. He can be reached at 1911 Marrion, Flagstaff, Arizona 86001, (Ph. 779-2492), to make advance plans.

Club members making out card lists for the holidays might like to include our friend and most faithful member, Harry Gragg who resides at the Veterans Administration facility in Hot Springs, S.D.

The Don Glesses are the proud grandparents of a baby girl born to their eldest son and wife, recently.

Merle Geyer is in the Veterans Hospital here in town and would appreciate communications from friends, I'm sure.

Barbara Allen is finally back in circulation after her long siege with broken bones this summer. Better luck in the coming months, Barb!

Helena Baegl was front page news in the late October issue of the Sun newspaper, along with her sister, Emma. Why didn't you give us a clue to your plans to travel to Alaska and British Columbia, Helena?

Jim Kratzer tells me he plans for semi-retirement, come January, so that he may spend more time with his wife who has been very ill. His several hobbies, including our own, will claim some of that leisure too.

Frank Rule and Roger Pabian were spotted by your reporter at the Clarinda Rock Show on October 21st, looking over some of the "goodies" and no doubt, buying a few.

Norna Miller is sporting a beautiful Montana variety sapphire and diamond ring, faceted by Ralph Ulrich, and set by Rick Shalberg who joined our club last year. Very striking!

Julius Young reports that Dr. Neihardt is working hard on the second volume of his autobiography. Those who have been fortunate to have read his first are eagerly looking forward to it.

George Balke tells me he plans to take a whole week off to do his bit for our '74 show. Line up here for his services, all you chairmen!

Continued next page

## GLENNA'S GLEANINGS (Continued)

Ruth Ternos is in St. Elizabeth Hospital, recovering from surgery. Get those cards and letters to her, friends!

One of our newer members, Mike Holmquist, recently held a grand opening for the jewelry store he has established in the Stuart Bldg. downtown.

The Tim Jeurinks were among seven couples whose lawn was judged to be outstanding in the Lincoln Lawn Awards Program.

Rick Shalberg has moved to Los Angeles after accepting a position with the Gemological Institute there. We're sorry to lose you Rick but wish you luck in your new adventure. Don't forget us - keep in touch.

Norma Miller was able to attend the Plains Conference of Archeology last week. Many papers were presented including one by Sandra Uridil (Chadron State College) - "Preliminary Analysis of Bison Bone Material from 1972 Field Session, Hudson-Meng Site". (NW Nebr.)

Remember - Arkansas field trip cancelled.

Let's not forget to make the reservations for the Christmas dinner party, to be catered by our own Don Eckel at the regular meeting place on Dec. 9th. Deadline is one week earlier for PREPAID reservations. See Norma Miller or myself---we would love to take your money.

Till next time, Glenna McGinnis

4-H News

The Petrified Pebble Pups of Lancaster County met at Van Dorn park for the Sept. achievement day program. Members and their families were treated to a pot luck supper. Then the meeting began. Members answered roll call by telling what they liked this past year. The news reporter reported over the whole year, and members realized it had been a good one. Then Lars Olson and Sequoia Flechs gave their demonstration on the identification of rocks, which had won a blue ribbon at the county fair. The club presented Mrs. Wells with a gift in appreciation of her work this year. The meeting was adjourned with two songs led by song leader, Diane Colborn. A reorganizational meeting was planned.

ANDREW OLSON club reporter

ATTENTION All NAOSCI Clubs ....

...A meeting is being called by the Steering Committee for the 1974 National Show on Sunday, November 26, 1972 at 1 P. M. in Kearney, Nebraska, to discuss progress on and participation in the 1974 National Show to be held in Lincoln. For this meeting it is requested that two delegates from each club be present. You will be notified of the meeting place in Kearney at a later time and of any changes that are made.

## NEIHARDT

## The Creative Flame

John G. Neihardt, Poet Laureate of Nebraska since 1921 and Prairie Poet Laureate of America since 1968, is approaching his 92nd birthday January 8, 1973. Few nonagenarians have so much still going on. His autobiography Vol. I, "All Is But a Beginning" ends with the eagle's cry -- "Hold fast, hold fast; there is more..."

His premier effort, a self-portrait in verse at age 12, he proudly titled "The Stubble-haired Boy". He soon realized he should improve his technique; and he did. Countless later poems, essays, books and recordings have flowed from this genius in eighty years of work with his pen, voice and nimble hands; all subjected to his exacting standards of workmanship.

That stubble-haired boy, now crowned with flowing white, is riding a wave of success, acclaim and popularity of impressive amplitude. The demand for his works, public programs and interviews is steadily increasing. Correspondence is world-wide. The famous "Black Elk Speaks" now appears in nine foreign languages; after being virtually forgotten for nearly forty years. Neihardt's many honors have not come from mere individual opinion or passing fancy, but from expert consensus. He has been a recognized poet laureate much longer than anyone in history. His Nebraska title came through Legislative Act, almost 52 years ago.

The poet has been an honorary member of Lincoln Gem and Mineral Club since 1967 and has exhibited several times here, and also at Salt Lake City in 1969. His lapidary and other handicrafts depended upon skill, not elaborate equipment. Fine gems have always fascinated him; and he has collected many. Another hobby is rare books. His collection of over 5,000 is a special feature of the University of Missouri Library at Columbia. Nearby is his Skyrim Farm of prize-winning horses.

"All Is But a Beginning" was released for sale in early October 1972. Popular demand caused additional printings in less than a month. This is not the run-of-the-mill autobiography; it is something that only John G. Neihardt can do. Reviewers nation-wide praise it highly. Thorpe Menn in the Kansas City Star says it is "a new dimension in autobiographies".

This first volume has an added bonus, - an inspired introduction by Lincoln's own Dick Cavett. It closes with a profoundly brilliant epilogue by Neihardt. Dick's TV interviews with the poet were unique highlights on ABC television network in 1971, and again in 1972.

Autobiography Volume II is progressing. Like its predecessor it is eagerly awaited by fans throughout the world. Three successive generations have been avid collectors of Neihardt materials which they hoard as precious, ancestral family heirlooms. His writings and recordings both in prose and in verse deal with real episodes in history; especially the western migration. Here are the reasons for the heritage value of his works:

- (1) The period in our culture covered so masterfully through his research and acquaintance cannot occur again.
- (2) There is little probability that other writers having such acquaintance could produce such skilful results.
- (3) There is only one Neihardt.

submitted by Julius D. Young

List of Materials on reverse side.

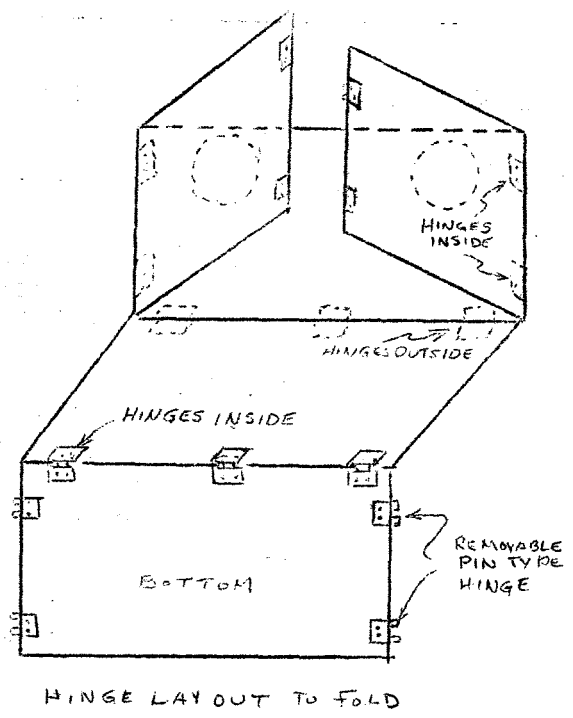
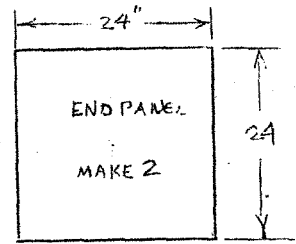
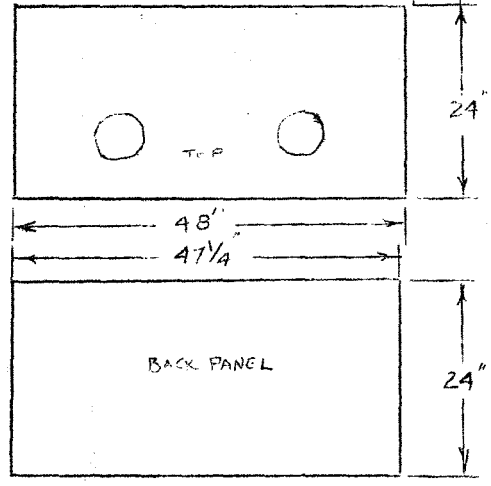
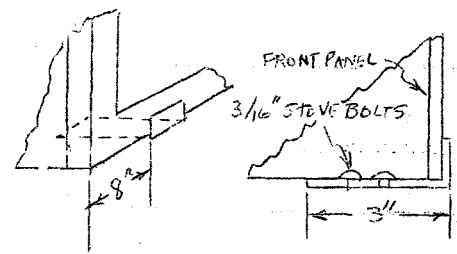
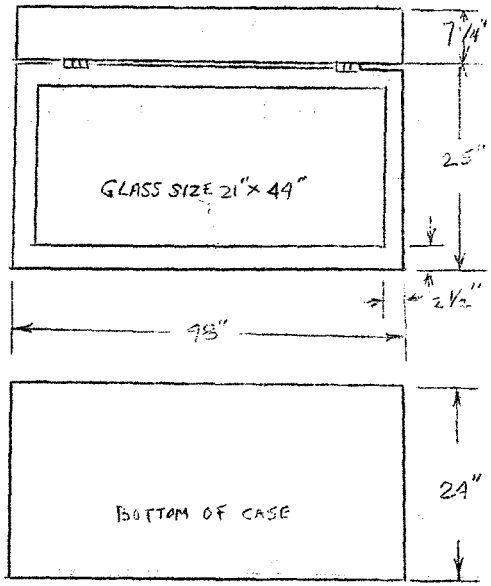
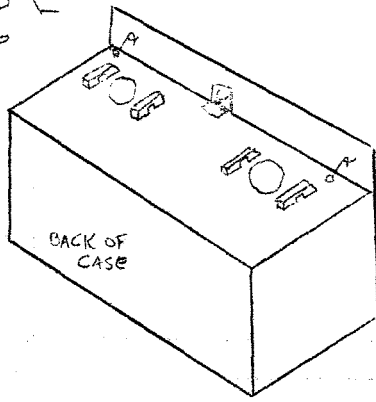
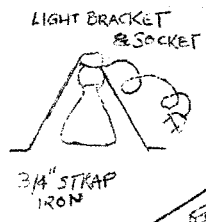
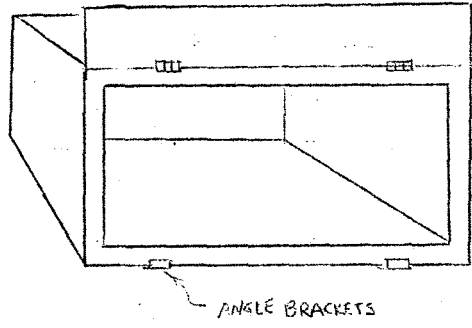

# NWF FOLDING CASE

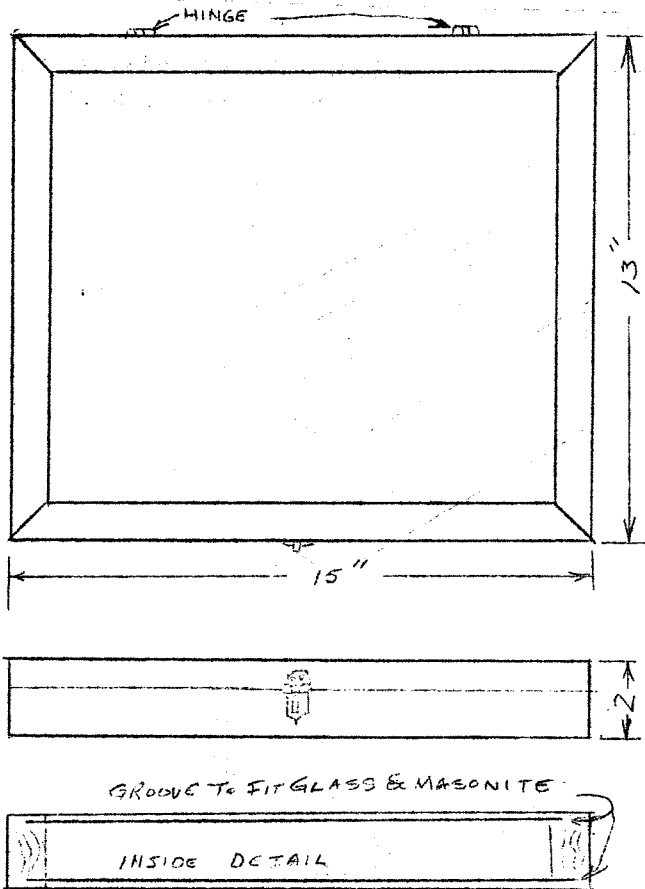

## MATERIALS NEEDED:

- 2 pieces of 1x2 15 inches long
- 2 pieces of 1x2 13 inches long
- 1 piece  $\frac{1}{8}$ " masonite 12x13 inches for bottom
- 1 piece glass 12x13 for top
- 2 small hinges & 1 tiny hasp

Glue or nail to suit

If deeper case is desired use either 1x3 or 1x4

If further help is needed please contact bulletin staff.

## LINCOLN CASE

### LIST OF MATERIALS FOR NORTHWEST FEDERATION 'FOLDING' DISPLAY CASE (PICTURED ON REVERSE SIDE)

- 2 No. 205 Utility Light Sockets
- 2 Reflector Flood Lamps
- 3 doz. 1" No.8 Screws
- Glass-Double Strength- 21" x 44"
- 4 x 8 Sheet  $\frac{3}{8}$ " Plywood
- 4 ft. 1x8
- 8 ft. 1x3
- 12 ft. 2" Sanitary Molding
- 2 2" x  $\frac{3}{4}$ " Butt Hinges
- 2 Screen Door Hooks
- 1 Padlock Hasp (small)
- 4  $\frac{3}{16}$ " Stove Bolts
- 4 ft.  $\frac{3}{4}$ " Strap Iron
- 10  $2\frac{1}{2}$ " Butt Hinges
- 4  $2\frac{1}{2}$ " Butt Hinges with removable pins

Detailed full scale plans are available. If interested contact Norma Miller.

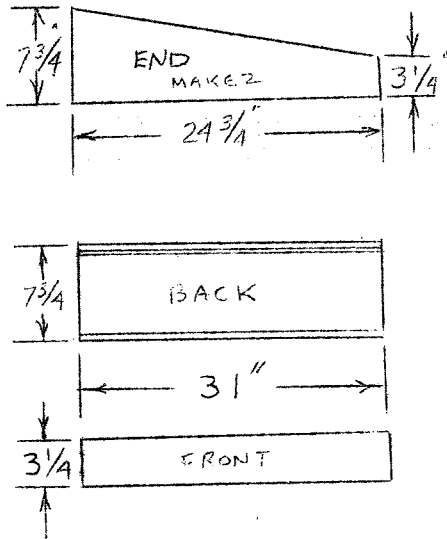
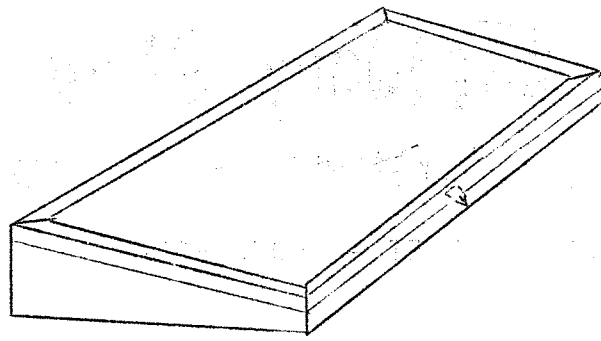

## MATERIALS

- 2 HINGES
- 1 - 1" x 8" x 10' BOARD
- 1 - HASP
- 1 - 30 1/4" x 24" TOP GLASS
- 10 - 1" BRASS SCREWS
- 1 PT. SPAR VARNISH

## WICHITA CASE

OPEN LETTER (received by Helena...it should stimulate your saving coupons)

HELENA BA EGL, SCHOLARSHIP CHAIRMAN, LINCOLN GEM & MINERAL SOCIETY

Dear Helena:

Thank you so very much for the fine package of Betty Crocker coupons that I received from you. The Lincoln Gem & Mineral Society has received credit for the 912 points in our Midwest Record Book. My special thanks to you again for the fine way that you always have your coupons, counted, trimmed and packaged. This is such a help to me.

Just for your information - according to my records you now have a balance of \$56.88 towards your 200% seal.

Please convey our appreciation to your members for their continued, loyal support of the American Federation Scholarship Foundation.

Sincerely yours, Katharine Steinbrenner (MWF Scholarship Chmn.)  
Sincerely yours, Katharine Steinbrenner (MWF Scholarship Chmn.)

# Everett Lapidary Shop

capitol city's first rock shop!!

2941 NORTH 65th STREET - PHONE 466-6204

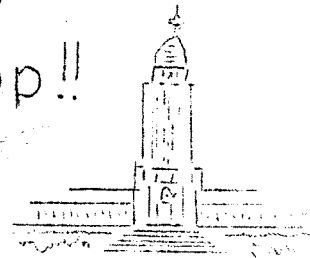
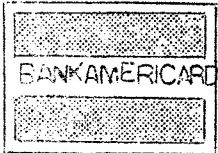

WE'RE BACK FROM OUR OLD MEXICO BUYING TRIP  
COME & SEE WHAT WE HAVE  
-ALSO MANY THINGS FOR CHRISTMAS

"SATISFIED CUSTOMERS ARE OUR BEST ADVERTISEMENT"

## FIRE AGATE

Fire agate is a chalcedony that has been deposited in layers. The fire comes from a thin coating of limonite deposited between the layers at the time of formation. Usually there is a large amount of matrix on the specimen, so soak it in water for at least ten minutes. This will help to determine which area of fire you want to bring out. Choose a portion that has a solid layer of chalcedony overlying the dark fire area.

Fire agates aren't much to look at in the rough, and are often passed by, but when ground and polished properly it exhibits sparkling red and green fire. Trim the sides and bottom, cutting the matrix with a trim saw. Carefully start grinding on the sides to the shape you want it. Use 120 grit. Be careful not to overheat the stone.

Mount the stone on a dop stick. Using 220 grit, work the top portion of the agate toward a high crown. As you grind down the top and sides watch for fire. A stone can be ruined at this point. If it is ground too far and into the limonite layer, the fire can be lost. Dip the stone close to the fire layer. Wet sanding can be used successfully, starting on 220 grit paper and finishing on 320 grit. Be sure not to overheat. Cerium oxide mixed with water to a thick paste and applied to a felt wheel for polishing will give you the best results.

Four important points to remember are: Choosing the area in the stone with the chalcedony overlying the limonite area, and not overheating the stone.

Via Gem News, SW Gems, & The Geode.

-----

UNION CARBIDE GROWS GIANT CRYSTAL...The 28,000 carat crystal (12 1/3 pounds) is over 8 inches long and 3 1/2 inches in diameter, and is believed to be the largest synthetic sapphire ever made. It took seven days to "grow" and represents a milestone in the crystal development program. Only 2 years ago, 2-pound synthetic sapphire crystals were the limit of capability. After being cut by diamond saws and finished by diamond polishing techniques, the large crystal will furnish components for precision optical instruments. Union Carbide employs the same crystal growth process to make its LINDE simulated diamonds and other synthetic gemstones for jewelry. (from Union Carbide Briefs, Dec. 1971, via Gem City Rock News)

ATTENTION ALL NAOESCI CLUBS...A meeting is being called by the Steering Committee for the 1974 National Show on Sunday, November 26th, at 1:00 PM at Kearney, Nebraska, to discuss progress on and participation in the 1974 National Show to be held in Lincoln. For this meeting it is requested that two delegates from each club be present. You will be notified of the meeting place in Kearney at a later time and of any changes that are made.

NOTICE TO LGMC MEMBERS...from your editor...after much thought and soul-searching I wish to express my desire to withdraw from the position of Editor of the Pick & Shovel so that I can have time to do some hobby work and keep my head on straight. I have devoted more time than I can afford to this position for some time now. I won't leave you high and dry, and I will help someone else become acquainted with the routine and details, so speak up, Kind People, and let your President know if you are willing to serve in this capacity. It's a great experience...you are a great bunch of people to be involved with and I have enjoyed my years as your Editor.

-Norma Miller

THOUGHT FOOD:

Don't worry if you didn't land in a bed of roses - just be thankful your parachute opened. (Right on?)  
 Cross your bridges before you come to them and you have to pay the toll twice!  
 TOO many people are willing to carry the stool when there's the piano to be moved!

SHOP HINTS: What lap to use? A good rule of thumb is "the harder the gem, the softer the lap".

A drop of S.T.P. on Garnet will help orient the star!

WE HAVE A NEW ADVERTISER THIS MONTH...MR. LEE PAVEL FROM

SRRAGUE, NEBRASKA 

AND PRODUCTION OF THIS AD IS NEW TO THE P & S THANKS TO ROGER SIMMONS AND HIS ACCESS TO THE NECESSARY EQUIPMENT TO REPRODUCE MATERIALS.

## TREASURE HUNTERS FIND

**You can't buy a better instrument than a WHITE'S!**

THE SENSATIONAL AND BEAUTIFUL GOLDMASTER 66T is the finest all-around Mineral and Metal Detectors made, and is second to no other—regardless of claims. TWO-YEAR GUARANTEE.

— IMMEDIATE DELIVERY —

*See This and Other Models manufactured by*



**DETECTS GOLD, SILVER AND COPPER NUGGETS, COINS, RINGS, JEWELRY, GUNS, AND ALL SORTS OF TREASURE. ALSO MAGNETIC ORE BODIES AND VEINS, ETC. SUPER-SENSITIVE TRANSMITTER-RECEIVER, THE 66-T COMES WITH TWO LOOPS. SEE IT TODAY AT:**

**WHITE'S ELECTRONICS**  
INCORPORATED

*Other Models as low as* **99.50**

**AT YOUR LOCAL DEALER**

Box 46  
Sprague, Nebr. 68438  
Ph. 794-5730

Lee Pavel  
L.P. Enterprises

OLDEST ROCK ON EARTH FOUND IN GREENLAND

Some of the oldest rocks in the world have been found on Greenland's south western tip near the city of Godthoab. A Geological team of 5 researchers from the University of Oxford, England and the Geological Survey of Greenland found gneisses, a coarse grained granitic rock, which date 3.98 billion years old.

Much of Greenland was affected by volcanic activity in the mid-Precambrian era so that rocks of this event of 600 million years ago are easily found. The earlier ages were mostly covered and obscured by this activity, however a small segment around Godthoab escaped and it was here the rocks were found.

The researchers have dated their finds by analyzing both the rubidium - strontium ratios and the ratios of isotopes of lead. Both are accepted methods of dating in use today, and are the same as used for the moon rocks. A gneiss recently found in Minnesota dated about 3.5 billion years old, but so far a rock literature now shows the Godthoab rocks are the oldest yet discovered.

After accretion of our planet from cosmic dust the most important event would be forming a core. This consolidation released a tremendous amount of radio active heat and energy, enough to melt the outer 1000 kilometers (621½ mi.) of the mantle, an event that must have preceded formation of a crust. As the cooling mantle formed a crust, heavier material sank and the lighter granites rose. It is from this original granitic crust the Godthoab rocks are believed to have come. Thus if the rocks dated near 4 billion then the earth itself must be 4.5 billion years old at least.

The Apollo 12 moon rocks dated 3.3 billion, Apollo 11 dated at 3.6 billion and Apollo 14 dated 3.9 billion. Recently the so called "Genesis Rock" found at the Apennine front was dated at 4.2 billion years old. Since the moon is presumed to have been formed by a collation of cosmic dust at the same time as the earth, but too large a bite for the earth's gravity to absorb and not large enough to escape its orbit, the time sequence should show a close fit on rock dating.

(Science News)--Submitted by Mrs. Harry R. Weimer, Peru YMCA Rock and Mineral Club.

-----  
DID YOU KNOW...

...that jade is doubtless the gem most resistant to breakage?  
It has a matted structure that makes it nearly immune to being broken.

...a horizontal lead lap, charged with natural emery powder served for many centuries to grind gems, prior to the invention of the silicon carbon grinding wheel.

...to remove peel-em-off cement from your hands, moisten your hands and apply comet cleanser. When rubbed in well it loosens the cement so that it washes off easily.

## PARLIAMENTARY PROCEDURE INSTITUTE

I attended the Parliamentary Procedure Institute sponsored by Nebraska State Association of Parliamentarians at Nebraska Center of Continuing Education, October 21, 1972. These are some of the highlites I gleaned from the lectures.

Parliamentary procedure is logic and common sense crystalized into a collection of rules of law.

Our first parliamentarian was Thomas Jefferson, who wrote a manual for large organizations to use. Later, General Henry Robert wrote a manual that is more generally used. It is named "Robert's Rules of Order." Then came "Robert's Rules of Order, Revised" and since, has come out a "New Revised Edition."

Robert's rules were: to benefit the majority, for protection of the minority and for the protection of the absent members.

There are three basic rules:

1. A CHARTER is needed if subordinate of a larger group, such as a state group. If property is handled, articles of incorporation are needed and a lawyer should help to interpret individual State laws and to work out legal problems for the individual group.
2. BY-LAWS, which require a previous notice, (so every member is informed) and a two thirds vote. These laws are to cover such items as: name, amount of dues, etc. These laws are for items that are more or less permanent.
3. STANDING RULES are for items that may have to be changed and may be changed without previous notice, but must have a two thirds vote. These rules are for such items as: time of meeting, place of meeting, etc.

There are eight essential items that should be in the By-Laws:

- |         |      |   |
|---------|------|---|
| Article | I    | - Name of Society   |
| "       | II   | - Object or purpose of Club   |
| "       | III  | - Membership (who qualifies)  |
| "       | IV   | - Officers, who and what are their duties.  |
| "       | V    | - Meetings, when, where, how are special meetings called, what constitutes a quorum.      |
| "       | VI   | - Committees, board of directors, executive, standing and appointees for a specific time. |
| "       | VII  | - Parliamentary authority, (Robert's?)  |
| "       | VIII | - Amendments, how to make them. Must have previous notice and two thirds vote.            |

Revision of By-Laws must have a vote of approval of the majority. A special committee may be three or five or what ever percentage of your particular Club that you deem adequate. A quorum is made up of a percentage of a reasonable number you expect to attend. Amendments and By-Laws go into effect immediately.

There are eight essential steps to obtain action on a Main Motion--  
Member -

1. Rises and addresses the Chair
2. Receives recognition from the Chair (cont'd.)

## PARLIAMENTARY PROCEDURE (Continued)

3. Introduces the motion
4. (Another member) Seconds the motion  
Chair (Presiding Officer)
5. States the motion
6. Calls for remarks
7. Takes the vote
8. Announces the result of the vote

You may not speak against your motion, but you may vote against it. If there are subsidiary motions to the main motion, each of these are voted on first in the order of their rank, which is:

1. MAIN (OR PRINCIPAL) MOTION - requires second, debatable, amendable, majority vote, reconsiderable.
2. POSTPONE INDEFINITELY - requires second, debatable, not amendable, requires two thirds vote if main motion, otherwise majority vote, affirmative, only, reconsiderable.
3. TO AMEND - requires second, debatable, amendable, requires majority vote, unless Main motion, then two thirds vote required, reconsiderable.
4. TO COMMIT OR RECOMMIT - requires second, debatable, amendable, requires majority vote, reconsiderable. (Means to refer to committee)
5. POSTPONE DEFINITELY - requires second, debatable, amendable, requires majority vote, unless main motion then two thirds vote, reconsiderable. (Means postponed to a definite future time.)
6. TO MODIFY DEBATE - requires second, not debatable, amendable, requires two thirds vote, reconsiderable.
7. PREVIOUS QUESTION - requires second, not debatable, not amendable, requires two thirds vote, reconsiderable.
8. TO TABLE - requires second, not debatable, not amendable, requires majority vote, not reconsiderable.

Those are the seven subsidiary motions and these are the five privileged motions:

9. CALL FOR ORDERS OF THE DAY - requires no second, not debatable, not amendable, no vote necessary, not reconsiderable.
10. QUESTION OF PRIVILEGE - requires no second, not debatable, not amendable, no vote necessary, not reconsiderable, (May interrupt member on floor).
11. TO TAKE A RECESS - requires second, not debatable, amendable, requires majority vote, not reconsiderable.
12. TO ADJOURN - requires second, not debatable, not amendable, requires majority vote, not reconsiderable.
13. TO FIX THE TIME TO WHICH TO ADJOURN - requires second, not debatable, amendable, requires majority vote, reconsiderable.

In the making of amendments, the Chair may state it is not germane if the Chair thinks the subject does not fit. This can be debated. The Chair may state, there being no further business the meeting is adjourned.

There are eleven incidental motions which have no rank among themselves. Their being in order depends upon their necessity at the time they are introduced.

1. APPEAL - requires second, not debatable, (except when applied to a debatable motion), not amendable, requires majority vote, reconsiderable. (May speak only once). (cont'd.)

## PARLIAMENTARY PROCEDURE (continued)

2. SUSPEND THE RULES - requires second, not debatable, not amendable, requires two thirds vote, not reconsiderable. (By-Laws may never be suspended).
3. POINT OF ORDER AND CALL TO ORDER - requires no second, not debatable, not amendable, Chair, not reconsiderable.
4. OBJECTION TO CONSIDERATION OF A QUESTION - requires no second, not debatable, not amendable, requires two thirds vote, only negative vote reconsiderable.
5. REQUESTS - requires no second, not debatable, not amendable, requires majority vote, not reconsiderable.
6. DIVISION OF THE ASSEMBLY - requires no second, not debatable, not amendable, requires majority vote, not reconsiderable, (Used when election results are in doubt).
7. TO READ A PAPER - requires a second, not debatable, not amendable, requires majority vote, reconsiderable.
8. TO WITHDRAW A MOTION - requires no second, not debatable, not amendable, requires majority vote, negative vote, only, reconsiderable.
9. TO DIVIDE THE QUESTION - requires no second, not debatable, amendable, requires majority vote, not reconsiderable.
10. TO CLOSE NOMINATIONS AND TO CLOSE THE POLLS - requires second, not debatable, amendable, requires two thirds vote, not reconsiderable.
11. TO CONSIDER SERIATIM - requires second, not debatable, amendable, requires majority vote, not reconsiderable.

There are two miscellaneous motions which are unclassified:

1. TO RECONSIDER - requires second, debatable, (when applied to a debatable motion), not amendable, requires majority vote, not reconsiderable.
2. TO TAKE FROM THE TABLE - requires second, not debatable, not amendable, requires majority vote, not reconsiderable.

Methods of voting:

1. BY VOICE
2. BY SHOW OF HANDS.
3. BY STANDING. This is used when a Division is called for. An easy way of counting is to have the Ayes stand and count off, sitting down after they have counted, then the Nays standing and counting off.
4. BY BALLOT. Best when there are more than one nominee for each office. There may be write-ins on the ballot.
5. ABSENTEE. May be by Proxy or by mail.
6. ROLL CALL. Each member's vote is recorded.

Choosing of Officers:

1. By nominations from the floor
2. By nominations of a nominating committee (which has been elected by the assembly).
3. By ballot.

The Chair declares the nominations closed. It is better not to have a secretary cast the ballot. The vote may not be unanimous. The Chair can quickly call for a standing vote that counts off. Should be by ballot if more than one nominee. Chair has each office voted on and asks for nominations from the floor each time. (cont'd.)

## PARLIAMENTARY PROCEDURE (Continued)

If voting by ballot, the Teller gives his report and the Chair announces the result. The Tellers report is recorded in the Secretary's book. Instead of having a majority vote, a plurality vote may be called for, especially if there are more than two nominees.

It should be stated in your By-Laws the length of term for each officer, but it should, also, state "officer shall stay in until his successor is elected."

Duties of Officers, as in Robert's revised, page 236:

## PRESIDING OFFICER:

Open meeting on time.  
 Tap gavel once to open meeting and at adjournment.  
 Stand, (may sit during chairmen's reports.)  
 Always say, The Chair, not I, in addressing assembly.  
 Release Chair to Vice Chairman, if you wish to speak on an issue.  
 Have Parliamentarian by side.  
 Chair votes by ballot or to break a tie.  
 Signs all orders.  
 States all motions and states results.  
 Represents her Club.  
 Should have order of business and carry it out.  
 Doesn't need to leave chair for reelection.  
 Acts as Ex-Officio on all committee meetings.

## ORDER OF BUSINESS:

Greetings and introduction of guests.  
 Reading of minutes - any corrections? If not they stand approved as read.  
 Treasurer's report - and questions? File for audit and amount entered in Secretary's book.  
 Other Officer's reports.  
 Committee reports.  
 Special committee reports.  
 Unfinished business  
 New business:  
     Correspondence read.  
     Announcements.

Adjourns.

VICE PRESIDENT: Must be ready to handle the Chair at any time the President isn't able to.

RECORDING SECRETARY: Should have copy of By-Laws.  
 Should have Robert's Rules or other authority.  
 Writes minutes and reads them.  
 Have membership list with addresses.  
 List of convention Delegates.  
 Keeps committee reports.  
 Records nominating committee's report.  
 Records Teller's report.  
 Signs only name unless a substitute, Then sign Pro Tem and name.

(cont'd.)

## PARLIAMENTARY PROCEDURE (Continued)

Should state in minutes the date, place and time of meeting. States only facts of meetings. Separate paragraph for each item. Record all main motions and the name of the member who made the motion. Then state whether seconded and carried or otherwise. If looseleaf book, pages should be numbered and initialed by the President. Should write in third person. Should state kind of meeting, whether board meeting, special meeting, general meeting, etc.

## TREASURER:

Money should be held in Club account and not personal.  
Should carry receipt book, check book and note book.  
Disburses money.  
Balance monthly.  
Audit annually.

---Mrs. Glen (Flossie) Litzenberg

(Thanks, Flossie, for reviewing these points for us...if we ever get stumped on procedure we may refer to Robert's rules to help keep us on an even keel. Ed.)

## ARE YOU THIS KIND OF ROCKHOUND?

"In a way, we are an odd lot because we have asked for no government appropriations to expand our recreational opportunities. We are inquisitive people, citizens with a thirst for knowledge regarding learning and discovery as great, and even spectacular as adventurers.

We lug home heavy bags of rocks which are worth little or nothing. But we also bring back color in our cheeks and muscles all limbered up, appetites like plow horses and an unwavering belief in our ability to jump over the garden gate. The rockhound does not destroy...he picks up stuff nobody wants or needs. If it should ever be needed it is well-preserved on tables, in livingrooms, on window sills, in basements, in pockets, on porches, and in trunks of cars owned by rockhounds.

Rockhounds just amble quietly along lake shores and up crooked ravines. They climb bluffs and mountains. Belly-deep breathing of hilltop air cleans the smog out their flues and burns the carbon from their valves.

Because they feel great they are agreeable, pleasant people to be with. Old rockhounds never die, they just petrify.."

Written by the late Matt Saari of Ely, Minnesota  
via the Topeka Gem & Mineral Club program & Glenna McGinnis

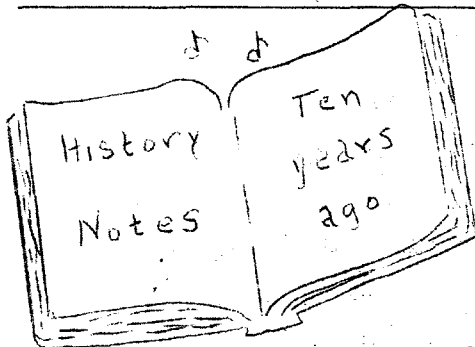

November - The business meeting of the Lincoln Gem & Mineral Club was held at Robert's Dairy Party Room.

A bust of ArtrBloyd was displayed and a contest was conducted to see how many could recognize the rockhound. Roger Simmons, John Lewis, Irl Everett, Carnegie, Herbert Hoover and Art Bloyd were some of the answers received.

-From the books of Frances Tracy, Historian

Hobbies overlap and to enhance this statement read the following article by Ivy Jones as it appeared in the Quarry Quips. Potters as well as lapidaries will enjoy reading...

#### JUST ANOTHER HARMONY OF NATURE

It is always pleasant to meet old friends. In vacillating between being a rockhound and being a potter I do often meet an old friend. In this experience, instead of breeding contempt familiarity breeds a feeling of understanding. Beginning with the most ordinary--Limestone of fossil fame.

Limestone is the source of whiting used in pottery. Whiting is a flux in high fire bodies and glazes. It is used in low fire to reduce porosity and lower vitrification temperature. Celestite produces the same effect but is more expensive.

Dolomite also a form from limestone is used more in glass making but is also used to promote longer and lower firing range in clay bodies.

Spodumene, closely related to the group, is an important source of lithia. The use of lithia as a flux develops the rich copper blue colors.

Copper is the major green colorant in pottery as cobalt is the major blue colorant. Cobalt is also used to produce pink and lavender with other minerals.

Galena the raw source of all lead compounds--it's use is a flux at low temperatures.

Soapstone is the source of potters talc. It lowers firing temperatures in clay bodies and is occasionally used in a glaze.

Pumice or Volcanic Ash is a very good glaze material. Kansas is abundant in this material.

Uranium as a yellow colorant is again available to the potter. It produces a clean yellow that comes from no other mineral.

One of the most important materials used by the lapidary artist is tin oxide. It is a polishing agent. In pottery it is an ingredient of glaze to cause a mat effect, giving a satin rather than a gloss finish. Tin is used in combination with cobalt to produce the color pink.

Nickel is the gray colorant for potters.

Iron in some form is used more than any other mineral in both bodies and glaze. It gives all the shades and tints of brown. Combined with other minerals produces the greys and blacks.

Salt has been used alone as a glaze since the Fifteenth Century.

Granite, decomposed is the source of Feldspar. There is not pottery without this mineral in some form.

Flint or to the rockhound Quartz, is equally important as feldspar.

Zinc is used for the same or similar purpose as tin. It costs less but takes a greater quantity. It is sometimes used in place of tin because of the different effect it has on color.

To me, Potters and Rockhounds are so closely related to nature and to each other they must be at least shirt tail cousins.

# Midwest Federation's NEWSLETTER

Published monthly except July and August as a service to members clubs.  
All news, articles, subscription orders and requests for information concerning publication  
should be sent to P. O. Box 1130, Des Moines, Iowa 50311



Issue No. 129 - November 1972

## Change In By-Laws

At the Council meeting in Marquette, Michigan on July 21, 1972, the following change in MWF by-laws was adopted.

### ARTICLE II, Section 1. Annual Dues

- a. Dues to this Federation shall be thirty five cents (35¢) per capita on all dues paying members of each adult society, with a minimum of two dollars and fifty cents (\$2.50), payable in advance. However, adult societies having junior members shall not be required to pay annual dues for junior members in excess of the annual dues of junior societies. For purposes of assessing dues in adult societies, only members under the age of sixteen shall be counted as junior members.

This changes the annual dues to 35¢ per club member, an increase of 10¢ and eliminates the maximum payment per club which has favored large clubs. Dues for Junior Societies, individual members and subscribing members are not changed. Of the 35¢, 10¢ goes to the American Federation as dues so the Midwest Federation has 25¢ per member to finance its program. This is still among the lowest of the Federations.

Gray Quarry, Hamilton, Illinois

## End Of The Line

A letter has been received from the management of the Gray Quarry in Hamilton, Ill. advising that they have decided to end all hunting in their quarry. This is the well known quarry from which many of the finest geode specimens have been found.

The letter from R. G. Blackledge, quarry man-

### WELCOME NEW MEMBERS

Mr. Ralph Rothbauer  
215 Thornton Avenue  
Youngstown, Ohio 44505

Mr. James F. Hartley  
23140 Harding  
Hazel Park, Michigan 48030

ager, explains, "We, Gray Quarries, Inc. of Hamilton, Illinois, a long-time quest of your members and affiliated clubs, can no longer permit rock hunters to trespass on our property. We were reluctantly forced to this conclusion because of the large numbers of people involved and the burden and expense of liability involved. We would appreciate your forwarding this message to everyone associated with your Federation. We would not like to see any members of the clubs associated with you make a long trip only to have it end in disappointment."

### Of Field Trip Convention

## Need 35mm Slides

35 mm. colored slides taken during the recent MWF Field Trip Convention at Ishpeming are needed to make up a slide program of the convention. Could I have extra slides that you don't need or could I borrow your slides long enough to duplicate them? (I have my own equipment so they wouldn't have to leave my possession for duplicating.) In particular I would like to have slides of the following events: Banquet, Chicken Barbecue, Pancake Breakfast, Meetings such as Delegates, Council, Editors, etc. Would also like to have interior shots of the Pel-

Slides... please turn to page 2

from page 1

## Slides

let Plant at Republic. Your cooperation would help make a more complete slide program, a copy of which will be given to the MWF program library. Send the slides to: Frazier H. Tubbs, 1710 Glendora Lane, Route 2, Ishpeming, Mich. 49849

## 1973 BULLETIN CONTEST

Editors, plan now to enter the 1973 MWF Bulletin Contest. May I suggest that you start with the October issue and save two copies of your bulletin. I will select one month from Oct. through March (Oct., Nov., or Dec. 1972; Jan., Feb., or Mar., 1973). It will be necessary to use one of these six issues because of the time involved in getting the copies to the MWF judge and the top ten in turn to the AFMS judge before convention time.

If you editors do not have my name on your mailing list, I would appreciate you placing it there. Paul W. Good, 118 N. Lindgergh Ave., Griffith, Ind. 46319.

## JUNIOR ACTIVITIES COMMITTEE

The Junior Activities Committee makes a final plea for your co-operation. If you have not filled out your clubs questionnaire on the needs and desires concerning Junior Activities, please do so now.

We are ready to compile a Junior Activities Bulletin for your use but we need your ideas now.

Send your questionnaire to: Mrs. Diane Dare, 335 Porter, Salem, Ill. 60548.

---

## HELP ELIMINATE LITTER

---

## SPECIAL DISPLAYS

The Special Displays Committee has a new member from Minnesota, Howard Moss, Box 13, Sandstone, Minnesota 55072.

We plan to have a supplement to our Special Displays Directory printed this winter and need assistance from anyone who has, or knows of an outstanding display, either amateur, dealer or working demonstration.

Your cooperation is appreciated by the committee.

## FROM THE EARTH SCIENCE CLUB OF NORTHERN ILLINOIS

We received this letter of praise on the Field Trip Convention.

At our first club meeting of the new season, it was suggested and unanimously approved that the Midwest Federation had done a "marvelous job" in planning and carrying to it's conclusion the Field Trip Convention in Michigan on July 20 - 24. This letter is backed by our many club members who attended the convention, and it carries their appreciation and their thank yous for the hard work done by so many people we do not know, but who certainly deserve some praise. The convention is still a topic of discussion in our club, and those who were unable to attend it feel that they missed out on something really great.

## FALL MEETING

The MWF Executive Committee met on Saturday, October 28, at the Ramada Inn in Aurora, Ill.

Lee Kirby was installed as the federations new president succeeding B. F. (Barney) Parr.

A complete report of the meeting will be reported in our December issue and minutes of the meeting will be sent to all member clubs.

LINCOLN GEM AND MINERAL CLUB, INC.  
P.O. BOX 5342, LINCOLN, NE 68505

REGULAR MEETINGS: 4th Saturday of the month, 7:30 PM, September through May  
W. O. W. Bldg., 732 S. 27th St., Lincoln, Nebraska

MEMBERS OF: Midwest Federation of Mineralogical and Geological Societies (MWF)  
American Federation of Mineralogical Societies (AFMS)  
Nebraska State Association of Earth Science Clubs, Inc. (NAOESCI)  
Community Arts Council of Lincoln (CAC)

1972 OFFICERS

President - - - Marie Wells, 2970 Vine St., Lincoln, NE 68503 435-6758  
1st Vice-Pres. - Roger Pabian, 300 Sycamore Dr., Lincoln, NE 68510 489-3081  
2nd Vice-Pres. - Ralph Ulrich, 3909 Pace Blvd., Lincoln, NE 68502 423-0419  
Rec. Secy. - - - Luella Paul, 3097 U St., Lincoln, NE 68503 477-2347  
Treasurer - - - Pam Dutcher, 5343 Cooper, Lincoln, NE 68506 488-0610

1972 BOARD MEMBERS

Irl Everett, 2941 N. 65th St., Lincoln, NE 68507 466-6204  
Jim Parks, 2435 S. 19th St., Lincoln, NE 68502 423-6798  
Tom Simmons, 2970 South St., Lincoln, NE 68502 488-1619  
Howard Taylor, 910 New Hampshire, Lincoln, NE 68508 432-3707

STANDING COMMITTEE CHAIRMEN

Liaison---Glenna McGinnis, 3444 Somerset Ave. 466-4878  
Safety---Lawrence Van Cleave, 6024 Gladstone 466-1838  
Hospitality---Marie Taylor, 910 New Hampshire 432-3707  
Refreshments---Marjorie Heedick, Margaret Simmons, 432-6117 and 432-4966  
Membership---Pat Lawson, 6328 X St. 434-2427  
1972 Show Chairman---Roger Pabian, 300 Sycamore Dr. 489-3081  
Vaja Con Dios Chamn---Marie Carveth, 2526 S. 11th 432-9100  
Historian---Frances Tracy, 3601 South St. 488-5341  
Librarian---Kathryn Ulrich, 3909 Pace Blvd. 423-0419  
Housing & Properties---Don Lawson, 6328 X St. 434-2427  
Field Trip---Tom Simmons, 2970 South St. 488-1619  
1972 Rock Swap---Howard Taylor, 910 New Hampshire 432-3707  
Education---Evelyn Ulrich, 3521 S. 48th St. 488-9051  
Program---Phyllis Parks, 2435 S. 19th St. 423-6798  
Calling Committee---Nelda Oliver, 5700 Otoe 489-5222  
Community Arts Council Rep---Rev. Raymond Pfeiffer, 8101 Sandalwood Dr. 488-1784  
Alternate---

NAOESCI Reporter---Norma Miller, 931 Cottonwood Dr. 489-8849

1974 SHOW STEERING COMMITTEE

Chairman - Ralph Ulrich                      Financial Chmn - Bruce Simon  
Sec. & Show Director - Irl Everett        Member-at-large - Howard Taylor

The purpose of this corporation shall be to study, promote an interest in, and disseminate knowledge of lapidary and various Earth Sciences including but not necessarily limited to geology, paleontology, and mineralogy. It shall be a particular purpose of the corporation to provide education in these fields to its members and the general public, particularly youth and student groups.

Articles published in the PICK & SHOVEL may be reprinted if credit is given the author and the bulletin, and a copy of the publication sent to the editor.

EDITOR: Norma Miller, 931 Cottonwood Dr., Lincoln, NE 68510 489-8849  
ASST. EDITOR: Phyllis Parks, 2435 S. 19th St., Lincoln, NE 68502 423-6798  
Editors members of N.A.B.E.

Lincoln Gem & Mineral Club  
Box 5342  
Lincoln, NE 68505

NON-PROFIT ORG.  
U.S. POSTAGE  
PAID  
LINCOLN, NE  
PERMIT NO. 176

Member: Community Arts Council

"THE PLACE TO GO IN 74"  
Nat'l Gem & Mineral Show  
June 13-16 Lincoln, Nebr.

LGMC Historian  
3601 South St.  
Lincoln, NE 68506

LINCOLN GEM & MINERAL CLUB ANNUAL SHOW, May 12-14, 1972, Fairgrounds, Lincoln, Nebr.  
NEBRASKA STATE SHOW - April 13-16, 1972, Hastings, Nebraska  
MWF FIELD TRIP CONVENTION - July 20-24, 1972, Ishpeming, Michigan  
THE KEY TO PROGRESS-'COOPERATION' - Barney Parr, MWF President 1972

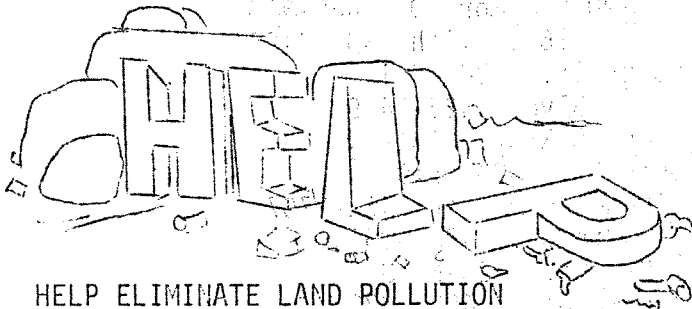

HELP ELIMINATE LAND POLLUTION

LINCOLN GEM & MINERAL CLUB - HOST

combined

MWF - AFMS NATIONAL SHOW & CONVENTION

and  
NEBRASKA STATE SHOW

JUNE 13-16, 1974, LINCOLN, NEBRASKA